

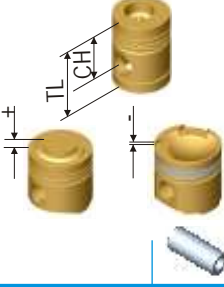











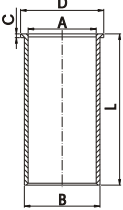
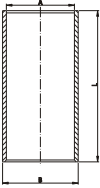
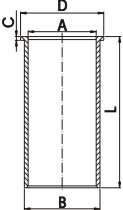

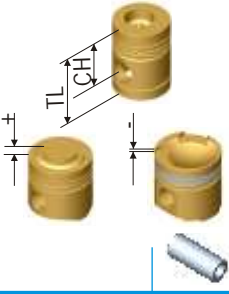



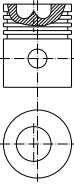
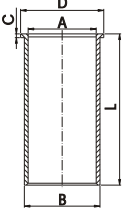
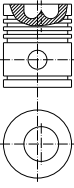
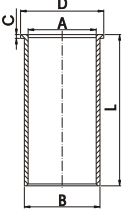
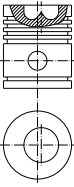
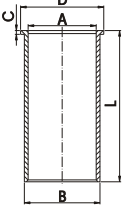

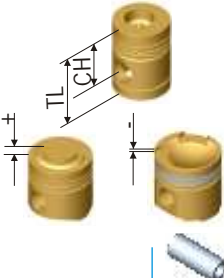
	No	Ø mm			Type			
<b>PERKINS</b>								
<b>Diesel Motor:</b> P 3.144, 2365 cm <sup>3</sup> , 28 KW (38 PS), 16.5:1 <b>Diesel Motor:</b> P 4.192, PA, PB, 3150 cm <sup>3</sup> , 37 KW (50 PS), 16.5:1 <b>Diesel Motor:</b> P 6.288, PF, PG, 4730 cm <sup>3</sup> , 46 KW (62 PS), 16.5:1 <b>Vehicle:</b> Phytan, Puma, Panther 1937...1962	3	88.925	57.20 107.90	31.75 x 75.30		2.385 R CRP 2.385 R P 3.160 N P 6.335 C P 6.335 BS P	88.925 P 53010 00	  A=88.925 B=93.71 L=216.00 D=94.45 C=4.76
<b>Diesel Motor:</b> T 3 -152 <b>Vehicle:</b> MF 225 T Tractors Uzel Part No: U 5 LU 0014	4	91.48	61.80 -18.80 109.40	31.75 x 75.30	ST	2.385 R CRP 2.385 R P 4.747 C CRP	91.48 P 53020 00	  A=91.48 B=93.739 L=215.90
<b>Diesel Motor:</b> 3.152, P 3.152, 2500 cm <sup>3</sup> , 33KW (45 PS), 17.4:1 <b>Diesel Motor:</b> 4.203, P 4.203, 3300 cm <sup>3</sup> , 45 KW (60 PS), 17.4:1 <b>Diesel Motor:</b> 6.305, P 6.305, 5000 cm <sup>3</sup> , 66 KW (90 PS), 17.4:1 1960...	3	91.48	57.20 107.90	31.75 x 75.30		2.385 R CRP 2.385 T P 3.160 TN P 6.350 C CRP 6.335 BS P	91.48 P 53024 00	  A=91.48 B=93.81 L=216.00 D=96.66 C=5.00

	No	Ø mm		Type				
<b>Diesel Motor:</b> D 3.152, 2500 cm <sup>3</sup> , 31-33.5 KW (42-45.5 PS), 18.4:1 <b>Vehicle:</b> Forklift	3	91.48	62.00 -18.44 109.63 	31.75 x 75.30	2.385 R CRP 2.385 R P 2.385 R P 6.350 C P	91.48	P 53026 00	 A=91.48 B=93.74 L=215.90 D=96.66 C=3.80
<b>Diesel Motor:</b> D 3.152, 2500 cm <sup>3</sup> , 31-33.5 KW (42-45.5 PS), 18.4:1 <b>Diesel Motor:</b> D 4.203, 3300 cm <sup>3</sup> , 40.5 KW (55 PS), 18.6:1 Direct Injektion <b>Vehicle:</b> Massey-Ferguson MF 135	3  4	91.48	62.00 -18.55 109.62   61.75 -18.30 109.37	31.75 x 75.30	2.385 R CRP 2.385 R P 3.160 TN P 6.350 C CRP 6.335 BS P	91.48  91.48	P 53028 00  P 53029 00	 A=91.48 B=93.81 L=216.00 D=96.66 C=5.00
<b>Diesel Motor:</b> D 3.152, 2500 cm <sup>3</sup> , 31-33.5 KW (42-45.5 PS), 18.4:1 <b>Diesel Motor:</b> D 4.203, 3300 cm <sup>3</sup> , 40.5 KW (55 PS), 18.6:1 Direct Injektion <b>Vehicle:</b> Massey-Ferguson MF 135	3  4	91.48	62.00 -18.55 109.62   61.75 -18.30 109.37	31.75 x 75.30	2.385 R CRP 2.385 T P 3.160 LAMEL 6.335 LAMEL 6.335 BS P	91.48  91.48	P 53032 00  P 53033 00	 A=91.48 B=93.81 L=216.00 D=96.66 C=5.00

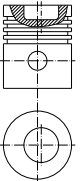
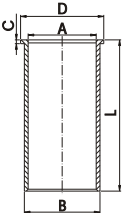
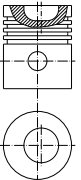
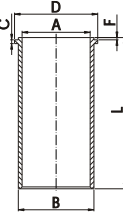
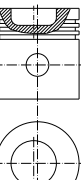
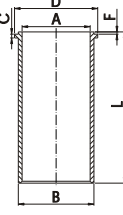
	No	Ø mm		Type				
<b>Diesel Motor:</b> 3.152 <b>Vehicle:</b> Massey-Ferguson Tractor MF 240-S	4	91.48	62.00 -19.25 109.60    61.63 -18.88 109.23	31.75 x 75.30	2.385 R CRP 2.385 R P 2.385 R P 4.747 C CRP	91.48	P 53036 00	  A=91.48 B=93.81 L=216.00 D=96.66 C=5.00
<b>Diesel Motor:</b> 4.212, 3475 cm <sup>3</sup> , 44-47 KW (60-64 PS), 15.5:1 Motor No: 712 UA 87004 1969...	4	98.48	76.50 -19.00 127.30    70.44 -20.59 121.24	34.925 x 84.10	2.385 R CRP 2.385 R P 2.385 N P 6.350 C CRP	98.48	P 53040 00	  A=98.48 B=103.33 L=227.28 D=106.42 C=3.80 F=0.90
<b>Diesel Motor:</b> A D 4-236, D 39 C, 3468 cm <sup>3</sup> , 57.5-59 KW (78-80 PS), 16:1 1969... <b>Vehicle:</b> Volvo, MF 275 Tractor, D 350 Truck	4	98.48	70.44 -20.59 121.24    70.15 -20.30 120.95	34.925 x 84.10 ST CP	2.385 R CRP 2.385 T P 4.747 C CRP	98.48	P 53042 00	  A=98.48 B=103.33 L=227.28 D=106.42 C=3.80 F=0.90
						98.48	P 53043 00	

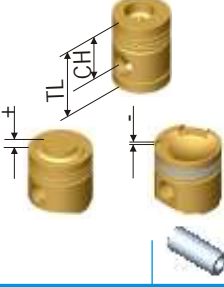
	No	Ø mm		Type				
<b>PERKINS</b>								
<b>Diesel Motor:</b> AD 4-236, D 39 C, 3864 cm <sup>3</sup> , 57.5-59 KW (78-80 PS), 16:1 <b>Direct Injektion</b> <b>Vehicle:</b> Volvo P4 1961... MF 275, MF 265 S Tractor, D 350 Kamyonet	4	98.48	70.68 -20.71 121.48  70.25 -20.28 121.05	34.925 x 84.10	2.385 R CRP 2.385 R P 2.385 N P 6.350 C CRP 6.335 BS P	98.48	P 53046 00	 A=98.48 B=103.33 L=227.28 D=106.42 C=3.80 F=0.90
<b>Diesel Motor:</b> AD 4-236, D 39 C, 3864 cm <sup>3</sup> 57.5-59 KW (78-80 PS), 16:1 <b>Direct Injektion</b> <b>Vehicle:</b> Volvo P4 1961... MF 275, MF 265 S Tractor, D 350 Kamyonet	4	98.48	70.61 -20.77 121.41  70.25 -20.41 121.05	34.925 x 84.10	2.385 R CRP 2.385 R P 2.385 R P 6.350 C CRP 6.350 S P	98.48	P 53050 00	 A=98.48 B=103.33 L=227.28 D=106.42 C=3.80 F=0.90
<b>Diesel Motor:</b> 6354.4, 5794 cm <sup>3</sup> 92 KW (125 PS), 16:1 <b>Vehicle:</b> AS 600, AS 700, Tractor 2620, 2640	6	98.48	70.50 -26.05 121.30  69.92 -25.50 120.72	34.925 x 84.10 ST CP	2.385 R CRP 2.385 T P 4.747 C CRP	98.48	P 5305400	 A=98.48 B=103.33 L=227.28 D=106.42 C=3.80 F=0.90
						98.48	P 53055 00	



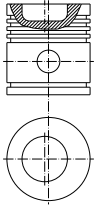
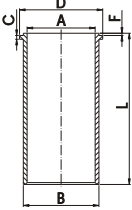
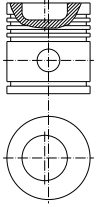
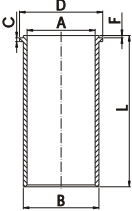
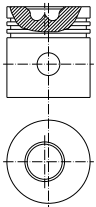
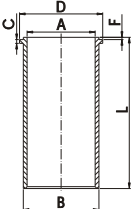
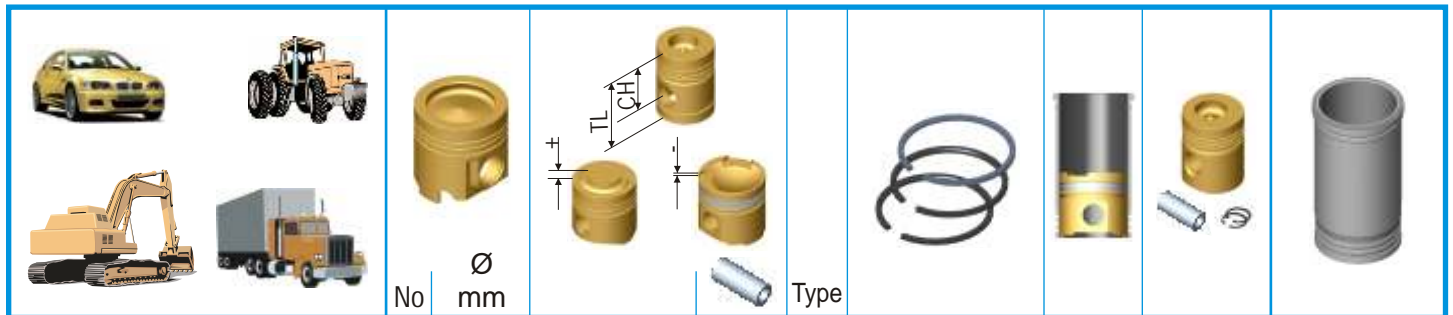



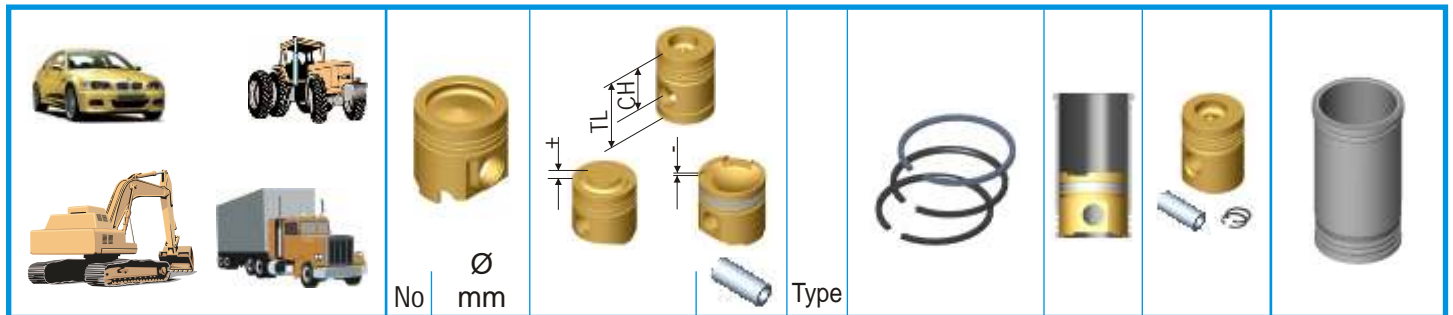



## PERKINS

	No	Ø mm			Type				
<b>Diesel Motor:</b> 4.212, 3475 cm <sup>3</sup> , 44-47KW (60-64 PS), 15.5:1 Direct Injection Motor No. is up to 712 UA 87004 <b>Vehicle:</b> MF 165 1969...	4	98.48	76.50 -19.20 127.30	34.925 x 84.10		2.385 R CRP 2.385 R P 2.385 N P 6.350 C CRP	98.48	P 53058 00	 A=98.48 B=103.33 L=227.28 D=106.42 C=3.80 F=0.90
<b>Diesel Motor:</b> T 6.354.4, 5800 cm <sup>3</sup> , 116 KW (155 PS), 15.5:1 Turbocharge <b>Vehicle:</b> PD 700 AS Truck Super	6	98.48	70.30 -19.30 108.30	38.10 x 82.80	ST CP	3.160 K MOP 2.385 T P 4.747 C CRP	98.48	P 53060 00	 A=98.48 B=103.33 L=227.28 D=106.42 C=3.80 F=0.90
			69.82 -18.82 107.82						
<b>Diesel Motor:</b> 4.248, 4065 cm <sup>3</sup> , 60 KW (82 PS), 16:1	4	100.96	70.30 -21.05 121.10	34.925 x 84.10		2.385 R CR 2.385 R 2.385 R 6.335 C	100.96	P 53070 00	

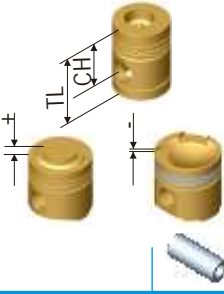

**PERKINS**

	No	Ø mm		Type					
<b>Diesel Motor:</b> 4.248, 4064 cm <sup>3</sup> , 62 KW (83 PS), 16:1 <b>Vehicle:</b> MF 285 S	4	101.054	70.30	34.925 x 84.10	CP	2.50 R MOP 2.50 MN P 5.00 C CRP	101.054	P 53080 00	 A=101.054 B=104.35 L=227.28 D=107.44 C=3.80 F=0.90
			-21.10					69.90	
<b>Diesel Motor:</b> 4.248, 4064 cm <sup>3</sup> , 62 KW (83 PS), 16:1 <b>Vehicle:</b> MF 285 S	4	101.054	70.30	34.925 x 84.10	CP	2.50 R MOP 2.50 MN P 5.00 C CRP	101.054	P 53084 00	 A=101.054 B=104.35 L=227.28 D=107.44 C=3.80 F=0.90
			-21.13					69.89	
<b>Diesel Motor:</b> 4.248, 4064 cm <sup>3</sup> , 61 KW (83 PS), 16:1 1969...	4	101.054	70.20	34.925 x 84.10	CP	2.385 R CRP 2.385 T P 2.385 N P 6.335 C CRP	101.054	P 53088 00	 A=101.054 B=104.35 L=227.28 D=107.44 C=3.80 F=0.90
			-21.00					69.92	
			121.10						
			-20.70						
			120.70						
			-20.72						
			120.69						
			-20.72						
			120.72						

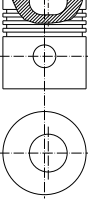
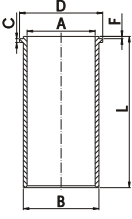
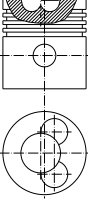
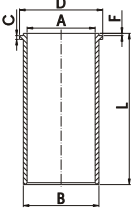
	 No    Ø mm		 Type				
<b>PERKINS</b>							
<b>Diesel Motor:</b> 4.248, 4064 cm <sup>3</sup> , 61 KW (83 PS) OEM :89207	4    101.054	69.92 -21.10 120.96  	34.925 x 84.10	2.385 R CR 2.385 TN 2.385 TN P 6.350 C	101.054	P 53092 00	  A=101.054 B=104.20 L=227.28 D=107.44 C=3.80 F=0.90
<b>Diesel Motor:</b> V 8.5 10, NA 180, 8360 cm <sup>3</sup> , 132.5 KW (180 PS), 16.5:1 Motor No: 510 U 2000 1966..	8    107.95	77.80 -19.70 -2.60 122.20  	41.275    ST x 90.50	2.385 R CRP 2.385 T P 2.385 N P 6.335 C CRP	107.95	P 53110 00	  A=107.95 B=113.18 L=226.00 D=116.66 C=2.60 F=0.66