

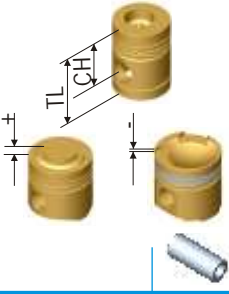











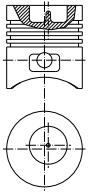
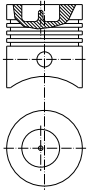
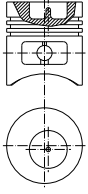
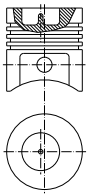

LOMBARDINI

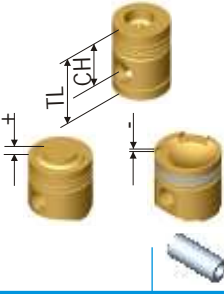
	No	Ø mm			Type			
Gazlı-Benzinli Motor: LAP 250 3 "Salma Su Motopompu"	1	72.00	34.70	15.00	2.00 R P	72.00	P 44010 00	
			59.70	x	2.00 N P	72.50	P 44010 10	
				54.70	4.00 DL P	73.00	P 44010 20	
Gazlı-Benzinli Motor: LA 300, LAP 300	1	76.00	32.70	15.00	2.00 R P	76.00	P 44020 00	
			57.70	x	2.00 N P	76.50	P 44020 10	
				54.70	4.00 DC P	77.00	P 44020 20	
Diesel Motor: Type: 520 3600 rev/min, 5 KW (6.5 PS)	1	78.00	44.00	20.00	2.00 R CRP	78.00	P 44030 00	
			-11.00	x	2.00 R P	78.50	P 44030 10	
			72.00	59.70	2.00 R P	79.00	P 44030 20	
Diesel Motor: Type: 530	1	82.00	44.00	20.00	2.00 R CRP	82.00	P 44050 00	
			-15.00	x	2.00 T P	82.50	P 44050 10	
			72.00	59.70	2.00 N P	83.00	P 44050 20	
					5.00 DC P			





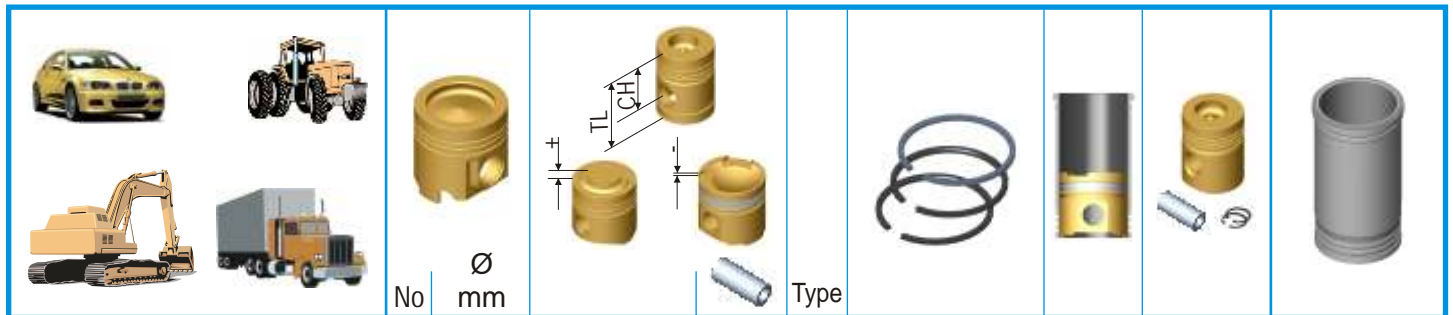



	No	Ø mm			Type				
LOMBARDINI									
Diesel Motor: 3 LD 450, 7.5 KW (10 PS) Vehicle: Water Pump Engine	1	85.00	52.00 -14.50 90.00 	23.00 x 63.10		2.00 R CRP 2.00 T P 2.00 T P 4.00 DC P	85.00 85.50 86.00	P 44060 00 P 44060 10 P 44060 20	
Diesel Motor: 3 LD 510, 510 cm ³ , 8.8 KW (12 PS), 17.5-18:1 Vehicle: Water Pump Engine	1	85.00	47.00 -16.50 85.00 	23.00 x 63.10		2.00 R CRP 2.00 T P 2.00 T P 4.00 DC P	85.00 85.50 86.00	P 44062 00 P 44062 10 P 44062 20	
Diesel Motor: 3 LD 510, 510 cm ³ , 8.8 KW (12 PS) 17.5-18:1 Vehicle: Water Pump Engine	1	85.00	47.40 -16.30 85.00  Combustion Bowl Ø 43.50	23.00 x 63.10		2.00 R CRP 2.00 T P 4.00 DC P	85.00 85.50 86.00	P 44064 00 P 44064 10 P 44064 20	
Diesel Motor: 4 LD 640 Vehicle: Water Pump Engine	1	95.00	58.00 -20.00 91.15  Combustion Bowl Ø 43.70	30.00 x 72.00		3.00 R CRP 3.00 T P 3.00 T P 5.00 DC CRP	95.00 95.50 96.00	P 44070 00 P 44070 10 P 44070 20	

	No	Ø mm			Type				
LOMBARDINI									
Diesel Motor: 4 LD 640, 638 cm ³ , 9.5 KW (13 PS), 17:1 Vehicle: Water Pump Engine	1	95.00	65.00 -16.00 111.00	28.00 x 78.00		3.00 R CRP 3.00 T P 3.00 T P 5.00 DC CRP	95.00 95.50 96.00	P 44072 00 P 44072 10 P 44072 20	
Diesel Motor: 5 LD 675-2, 1340 cm ³ , 20.6 KW (28 PS), 17.5:1 Direct Injection Diesel Motor: 5 LD 675-3, 2019 cm ³ , 31 KW (42 PS), 17.5:1 Direct Injection Diesel Motor: 5 LD 675-4, 2692 cm ³ , 41.2 KW (56 PS), 17.5:1 Direct Injection Vehicle: Water Pump Engine	2	95.00	60.00 -16.00 100.50	28.00 x 78.00		3.00 R CRP 3.00 T P 3.00 T P 5.00 DC CRP	95.00 95.50 96.00	P 44074 00 P 44074 10 P 44074 20	
Diesel Motor: 5 LD 675-2, 1340 cm ³ , 21 KW (28 PS), 17.5:1 Direct Injection Diesel Motor: 5 LD 675-3, 2019 cm ³ , 31 KW (42 PS), 17.5:1 Direct Injection Diesel Motor: 5 LD 675-4, 2692 cm ³ , 41 KW (56 PS), 17.5:1 Direct Injection Vehicle: Water Pump Engine	3	95.00	60.00 -16.00 99.50	28.00 x 74.00		3.00 R CRP 3.00 T P 3.00 T P 5.00 DC CRP	95.00 95.50 96.00	P 44076 00 P 44076 10 P 44076 20	

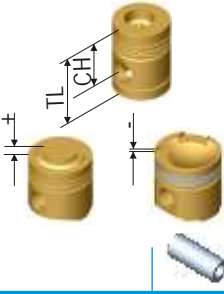

LOMBARDINI

	No	Ø mm		Type			
Diesel Motor: 8 LD 665-2, Direct Injection Vehicle: Water Pump Engine	1	95.00	58.00	28.00 x 72.00	2.50 R CRP 2.50 T P 5.00 DC CRP	95.00	P 44078 00
			-20.00			95.50	P 44078 10
			91.00			96.00	P 44078 20
Diesel Motor: 5 LD 825-2/L, 1649 cm ³ , 25 KW (34 PS), 17.4:1 Direct Injection Diesel Motor: 5 LD 825-3/L, 2474 cm ³ , 38 KW (52 PS), 17.4:1 Direct Injection Diesel Motor: 5 LD 825-4/L, 3299 cm ³ , 48.5 KW (66 PS), 17.4:1 Direct Injection Vehicle: Water Pump Engine	2	100.00	65.00	32.00 x 84.00	3.00 R CRP 2.50 T P 2.50 T P 5.00 DC P	100.00	P 44080 00
			-21.00			100.50	P 44080 10
			102.25			101.00	P 44080 20
			Combustion Bowl Ø 45.00				
Diesel Motor: 5 LD 825-2/L, 1649 cm ³ , 25 KW (34 PS), 17.4:1 Direct Injection Diesel Motor: 5 LD 825-3/L, 2474 cm ³ , 38 KW (52 PS), 17.4:1 Direct Injection Diesel Motor: 5 LD 825-4/L, 3299 cm ³ , 48.5 KW (66 PS), 17.4:1 Direct Injection Vehicle: Water Pump Engine	2	100.00	65.00	32.00 x 84.00	2.50 R CRP 2.50 T P 3.50 DC CRP	100.00	P 44082 00
			-19.00			100.50	P 44082 10
			100.00			101.00	P 44082 20
			Combustion Bowl Ø 51.00				

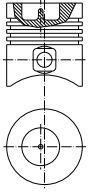
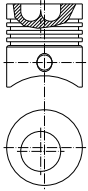
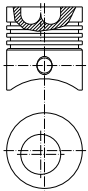
	 No Ø mm		 Type					
LOMBARDINI								
Diesel Motor: 4 LD 705, 707 cm ³ , 11 KW (15 PS), 17.54:1 Direct Injection Vehicle: Water Pump Engine	1	100.00	65.00 -16.00 110.75  Combustion Bowl Ø 49.70	28.00 x 74.00	2.50 R CRP 2.50 T P 2.50 T P 5.00 DC P	100.00 100.50 101.00	P 44084 00 P 44084 10 P 44084 20	
Diesel Motor: Direct Injection Vehicle: Water Pump Engine	1	100.00	65.00 -19.00 110.75  Combustion Bowl Ø 49.70	28.00 x 78.00	2.50 R CRP 2.50 T P 2.50 T P 5.00 DC P	100.00 100.50 101.00	P 44086 00 P 44086 10 P 44086 20	
Diesel Motor: 4 LD 820, 827 cm ³ , 12 KW (17 PS) Vehicle: Tractor Ba ak 17	1	102.00	60.00 -18.00 102.00  Combustion Bowl Ø 54.00	28.00 x 80.00	3.00 R CRP 2.50 T P 2.50 T P 5.00 DC CRP	102.00 102.50 103.00	P 44090 00 P 44090 10 P 44090 20	