

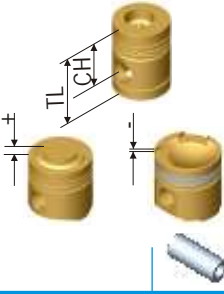









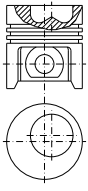
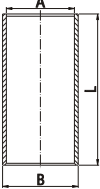
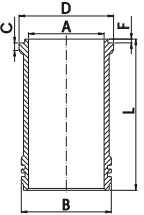

	No	Ø mm			Type				
<b>CATERPILLAR</b>									
<b>Diesel Motor:</b> 3160 <b>Vehicle:</b> D 320 613 Scraper 9L 6979 9N 579 9L 9363	4 6 8	114.30	58.85 -21.00 93.20	38.10 x 81.40	ST	2.385 2.350 6.335	114.30 .020"	P 19010 00 P 19010 20	
<b>Diesel Motor:</b> 3208 <b>Seri No:</b> 29 A1 90 N1 75 V 4002 32 Y1 1 Z1 3 Z1 9 N-579 9 N-580	8	114.30	58.93 -20.93 93.23	38.10 x 81.40	ST	3.160 R 2.771 C CR	114.30 .020" .040"	P 19012 00 P 19012 20 P 19012 40	 <p>A=114.30 B=119.14 L=196.85</p>
<b>Diesel Motor:</b> 3304, 7000 cm <sup>3</sup> , 46-97 KW (62-130 PS), 17:1 <b>Vehicle:</b> Loader 931,-941,-950,-951 Tractor D 3,-D 4,-D 5 Radiader 910,-955 Skidder 518 <b>Diesel Motor:</b> 3306, 10500 cm <sup>3</sup> , 78-147 KW (106-200 PS)	4  6	120.65	73.99 -14.30 -7.34 -6.76 115.06	38.128 x 94.90	DST	3.160 R CRP 2.385 T CRP 5.535 C CRP	120.65	P 19020 00	 <p>A=120.65 B=134.35 L= 255.00 D=143.00 C=10.30 F=1.00</p>

	No	Ø mm			Type				
<b>CATERPILLAR</b>									
<p><b>Diesel Motor:</b> 1673 C <b>Seri No:</b> 69 D 1... 76 E 1...</p> <p><b>Diesel Motor:</b> D 330 C <b>Seri No:</b> 4 B 1...4 B 4554 5 B 1...5 B 1008</p> <p><b>Diesel Motor:</b> D 333 C <b>Seri No:</b> 66 D 1... 67 D 1... 62 U 1...</p> <p><b>Diesel Motor:</b> 3304, 6947 cm<sup>3</sup>, 46-101 KW (62-137 PS), 17:1 <b>Seri No:</b> 4 B 4555... 5 B 1009...</p> <p><b>Diesel Motor:</b> 3306, 93-186 KW (126-252PS), 17:1 <b>Vehicle:</b> Crawler Dozer D 7F, Wheel Loader Type 980 B, Pipelayer 571 F,-572 F, Scraper &amp; Two Wheel Loader 627,-637, Motor Grader 14 D, <b>Seri No:</b> 66 D 8891... 67 D 1103... 69 D 1... 3 N 1... 76 R 273... 44 V 1... 47 V 1... 49 V 1...</p>	4	120.65	73.80 -14.00 -7.40 -6.70 115.12	43.18 x 95.90	DST	3.160 R CRP 2.385 T CRP 5.535 C CRP	120.65	P 19022 00	 <p>A=120.65 B=134.35 L= 255.00 D=143.00 C=10.30 F=1.00</p>
<p><b>Diesel Motor:</b> 3306, (8 N 3102) <b>Vehicle:</b> D7 G, 65 V</p>	6	120.65	74.00 -19.90 130.00	38.128 x 94.90	DST	3.120 K CRP 3.120 TK CRP 3.150 C CRP	120.65	P 19024 00	 <p>A=120.65 B=134.35 L= 255.00 D=143.00 C=10.30 F=1.00</p>

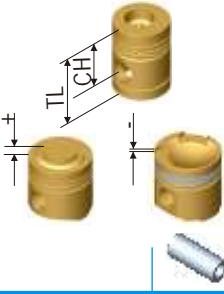

## CATERPILLAR

	No	Ø mm			Type				
<b>Diesel Motor:</b> 343, 9 S-2266 Model: Cat.988	6	137.16	104.50 -5.80 157.40	50.80 x 116.10	DST	2.385 2.385 6.350	137.16	P 19030 00	
<b>Diesel Motor:</b> D 3408, <b>Seri No:</b> 67U1 UP, 99U1 UP, 28V1 UP <b>Disel Motor:</b> D3412 <b>Seri No:</b> 60M1 UP, 38S1 UP <b>Vehicle:</b> C.Dozer D7, D8 L,D9 L	8  12	137.16	88.00 -16.00 137.50	50.80 x 111.90	DST	3.965 K CRP 3.110 K 3.150 C CRP	137.16	P 19032 00	<p>           A=137.16            B=153.65            L= 274.50            D=165.20            C=8.88            F=1.00         </p>

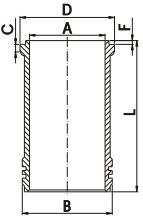
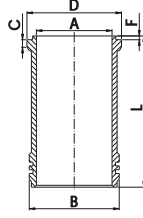
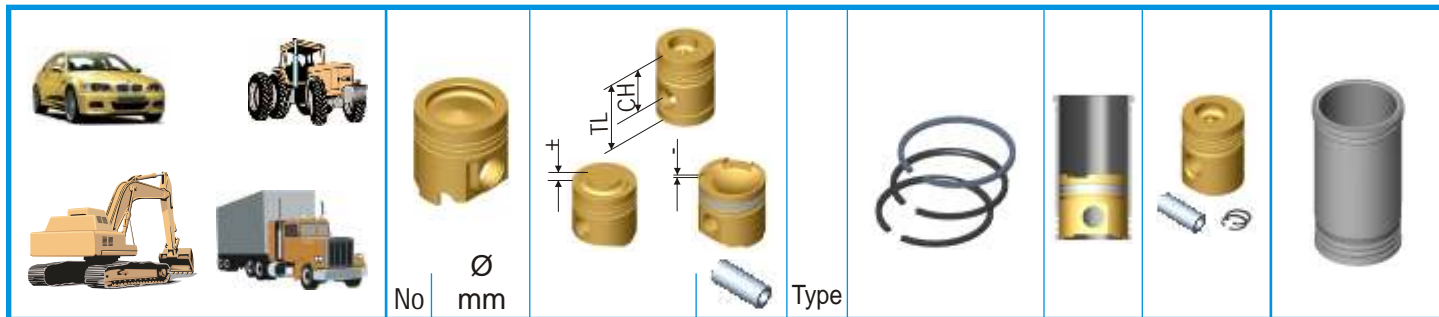
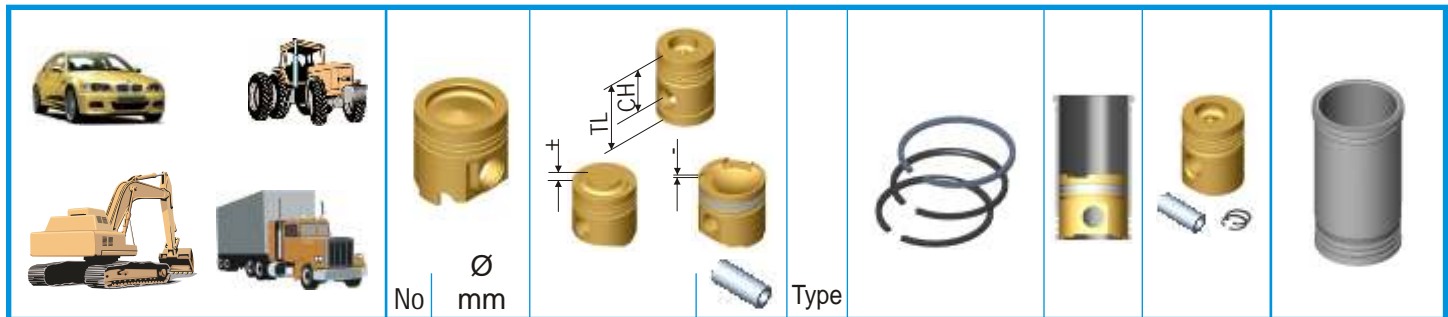

## CATERPILLAR

	No	Ø mm		Type				
<b>Diesel Motor:</b> D 339, 13620 cm <sup>3</sup> , 94KW (128 PS) <b>Seri No:</b> 34 B 1 <b>Diesel Motor:</b> D 13000, <b>Seri No:</b> 28 B 1...28 B 504, 29 B 1...29 B 41, 30 B 1...30 B 69, 1 T 1...1 T 478, <b>Diesel Motor:</b> D 342 C, <b>Seri No:</b> 31 B 1...31 B 2477, 31 B 1...32 B 1539, 17 S 1...17 V 2854, 50 V 1 <b>Diesel Motor:</b> D 342, 20400 cm <sup>3</sup> , 136 - 235.5KW (185 - 320PS), 15.7:1 <b>Seri No:</b> 31 B 1...31 B 2477, 32 B 1...32 B 1539, 17 S 1...17 V 2854, 50 V 1 <b>Diesel Motor:</b> D 375 D, <b>Seri No:</b> 43 B 1, 44 B 1...44 B 650, <b>Diesel Motor:</b> D 364, 27250 cm <sup>3</sup> , 175 - 357KW (238 - 485PS), 16:1 <b>Seri No:</b> 19 B 1...19 B 335, 20 B 1...20 B 102, 21 B 1...21 B 368, <b>Diesel Motor:</b> D 375, 27250 cm <sup>3</sup> , 175 - 357KW (238 - 485PS), 16:1 <b>Seri No:</b> 16 B 1...16 B 439, 17 B 1...17 B 211, 18 B 1...18 B 197, <b>Diesel Motor:</b> D 397 D, <b>Vehicle :</b> D7,D8, Serie 13A/ 14A/15A/17A 1954... <b>Seri No:</b> 41 B 1...41 B 2498, 42 B 1...42 B 458, <b>Diesel Motor:</b> D 386, 40800 cm <sup>3</sup> , 265 - 537KW (360 - 730PS), 16:1 <b>Seri No:</b> 13 B 1...13 B 258, 14 B 1...14 B 29, 15 B 1...15 B 71, <b>Diesel Motor:</b> D 397, 40800 cm <sup>3</sup> , 265 - 537KW (360 - 730PS), 16:1 <b>Seri No:</b> 10 B 1...10 B 725, 11 B 1...11 B 175, 12 B 1...12 B 399,	4	146.05	131.70 -21.75 -6.73 207.98	60.71 x 120.30	DST	4.747 R CR 2.385 T CR 6.335 C CR	146.05	P 19040 00
		6					3.947 K CR 3.947 K 6.335 BS CR	146.05
	6							
	6							
	8							
	8							
	8							
	12							
	12							
	12							
	12							

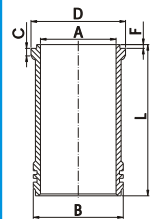

A=146.05  
B=168.30  
L= 382.50  
D=177.40  
C=12.70  
F=1.00